

B1 Ø6 MM X 30 MM 28 X	J Ø10 MM X 44 MM 33 X	D Ø12 MM X 10 MM 2 X	E Ø6 MM X 35 MM 7 X	L 19 MM 13 g	F1 13 g
M6 Ø6 MM X 16 MM 20 X	M2 Ø6 MM X 25 MM 4 X	W31 3 X	Q4 INSET 6 X	Q5 HALF OVERLAY 3 X	U Ø16 MM 3 X
AG1 1 X	AI1 BLACK 4 X	BB 12 MM 2 X	BB4 12 MM 2 X	CA3 SAYAP BLACK 12MM 1 X	AT 1 X
F 13 MM 6 g	M3 Ø6 MM X 13 MM 61 X	Y1 300 MM 1 SET	AG 2 X		

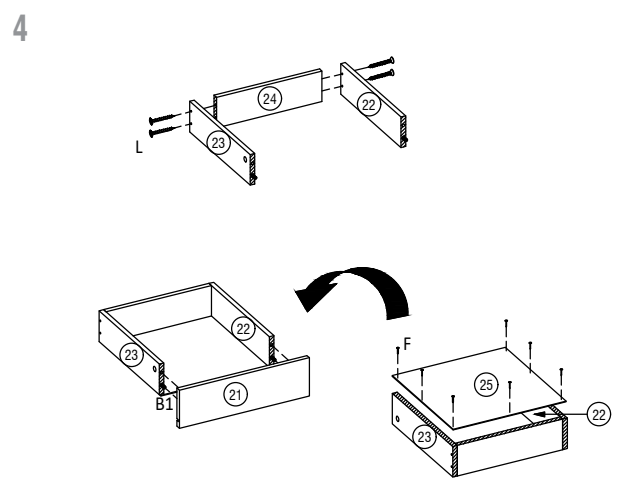

5

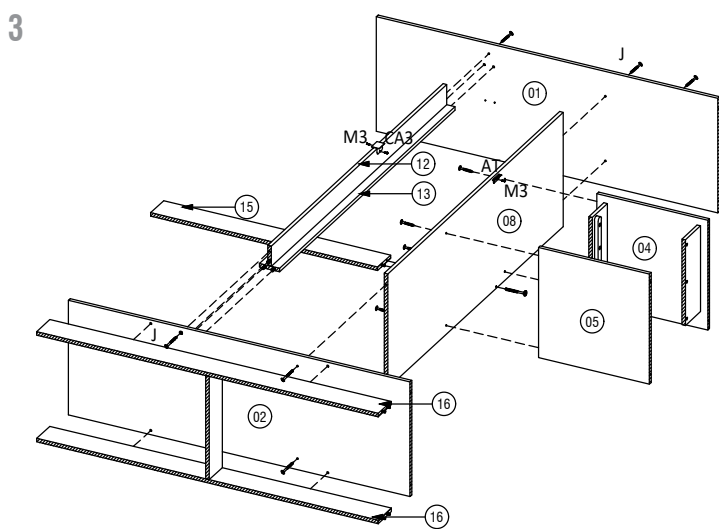
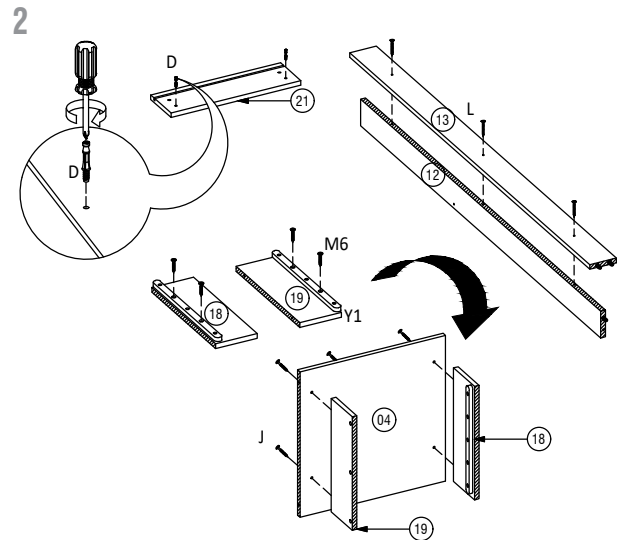
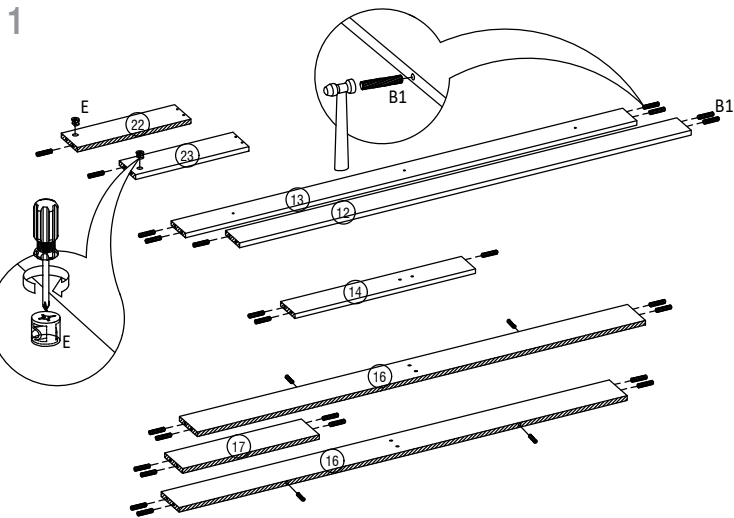
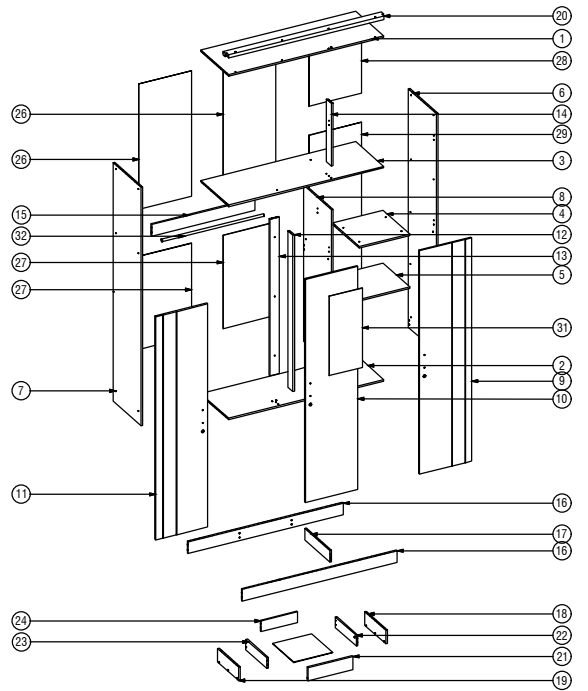
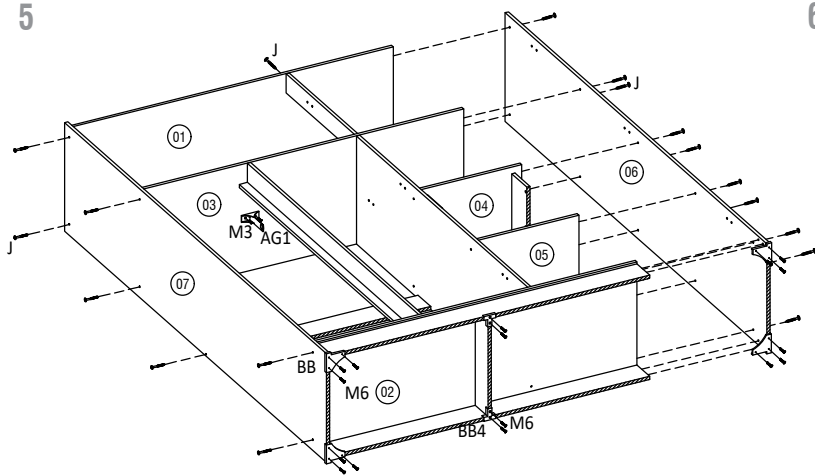

6

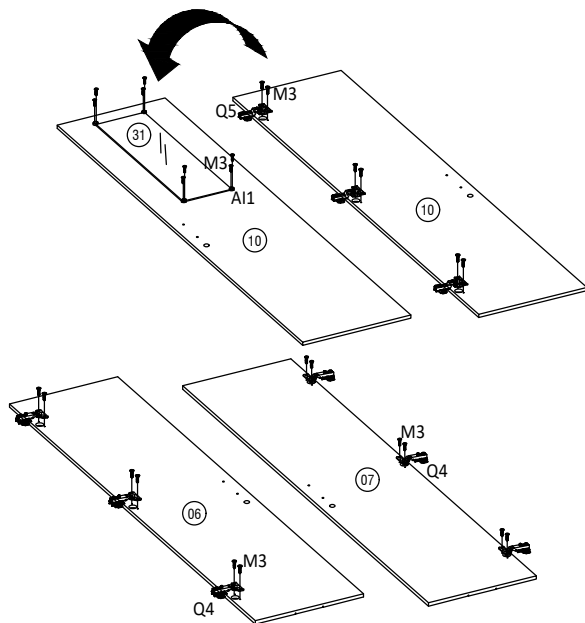

7

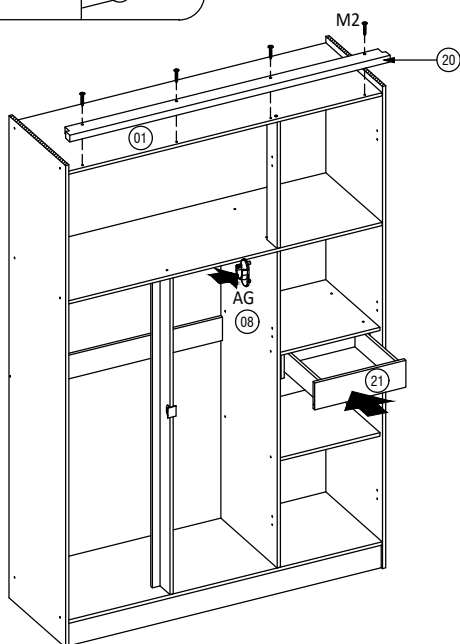

8

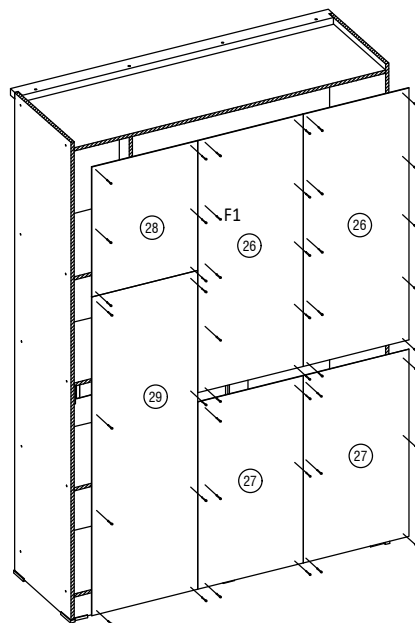

9

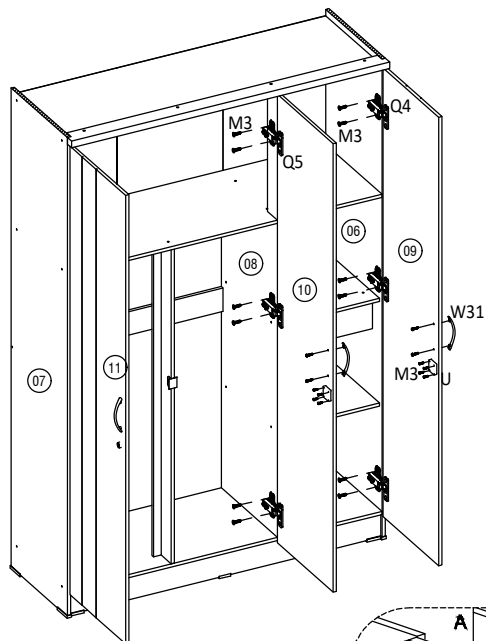

10

